

Judo III Superturniir 11.02.2019 Sole Spordihoone C -30kg

Competitors

Competitors: 4

#	Name	Grade	Club	1	2	3	4	Wins	Pts	Pos
1	Kristjan BACHMANN	?	Audentes		10	10		2	20	1
2	Kristian KERMON	?	Audentes				10	1	10	4
3	Taaniel RAUD	?	Barra		10			1	10	3
4	Daniil ARHIPOV	?	Kibuvits	10		7		2	17	2

Matches

Match	White	Grade	Blue	Grade	Result	Time
1	Kristjan BACHMANN	1	Kristian KERMON	2	10s1-00s1	1:58
2	Taaniel RAUD	3	Daniil ARHIPOV	4	00-01s1	3:00
3	Kristjan BACHMANN	1	Taaniel RAUD	3	10-01	2:51
4	Kristian KERMON	2	Daniil ARHIPOV	4	10-00	1:08
5	Kristjan BACHMANN	1	Daniil ARHIPOV	4	00-10s1	1:06
6	Kristian KERMON	2	Taaniel RAUD	3	00-10	0:44

Results

Pos	Name
1	Kristjan BACHMANN, Audentes
2	Daniil ARHIPOV, Kibuvits
3	Taaniel RAUD, Barra
4	Kristian KERMON, Audentes

Judo III Superturniir 11.02.2019 Sole Spordihoone C -34kg

Competitors: 7

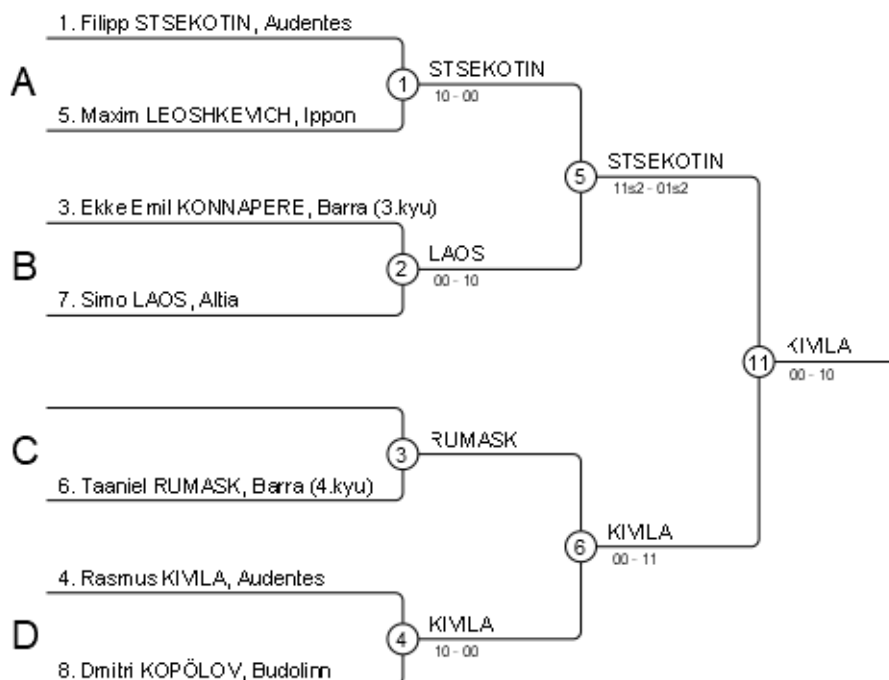

Results

Pos	Name
1	Rasmus KIVLA, Audentes
2	Filipp STSEKOTIN, Audentes
3	Ekke Emil KONNAPERERE, Barra
3	Dmitri KOPÖLOV, Budolinn
5	Taaniel RUMASK, Barra
5	Simo LAOS, Altia
7	Maxim LEOSHKEVICH, Ippon
7	

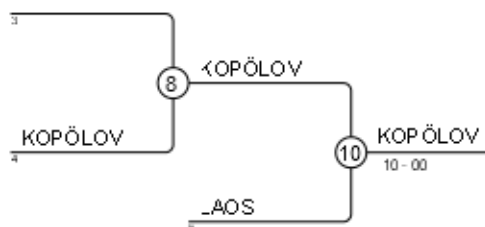
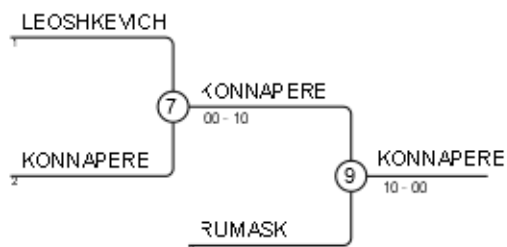

Judo III Superturniir 11.02.2019 Sole Spordihoone C -38kg

Competitors: 9

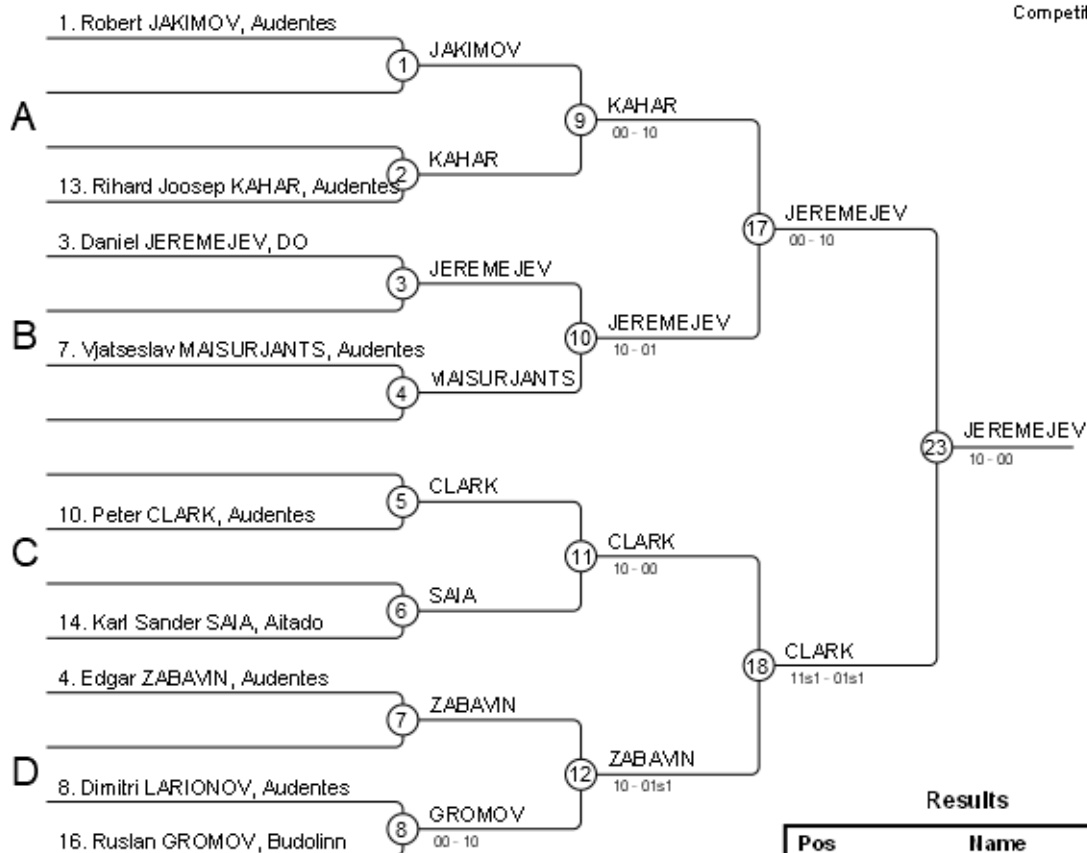

Results

Pos	Name
1	Daniel JEREMEJEV, DO
2	Peter CLARK, Audentes
3	Robert JAKIMOV, Audentes
3	Rihard Joosep KAHAR, Audentes
5	Edgar ZABAVN, Audentes
5	Karl Sander SAIA, Aitado
7	Vjatseslav MAISURJANTS, Audentes
7	Ruslan GROMOV, Buddinn

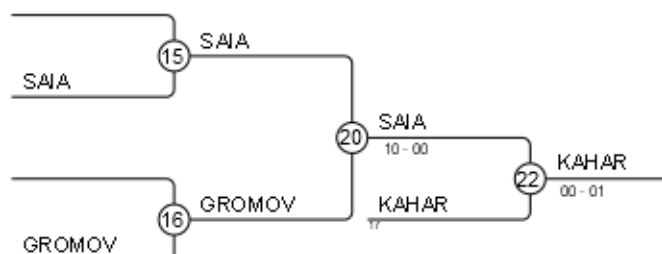
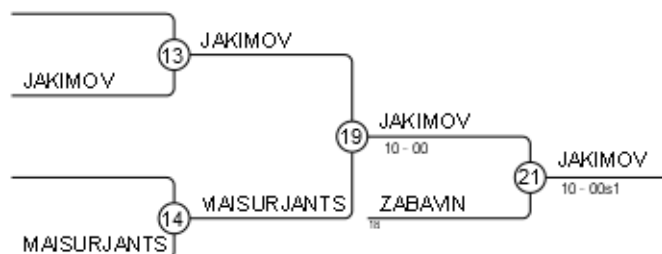

Judo III Superturniir 11.02.2019 Sole Spordihoone C -42kg

Competitors: 6

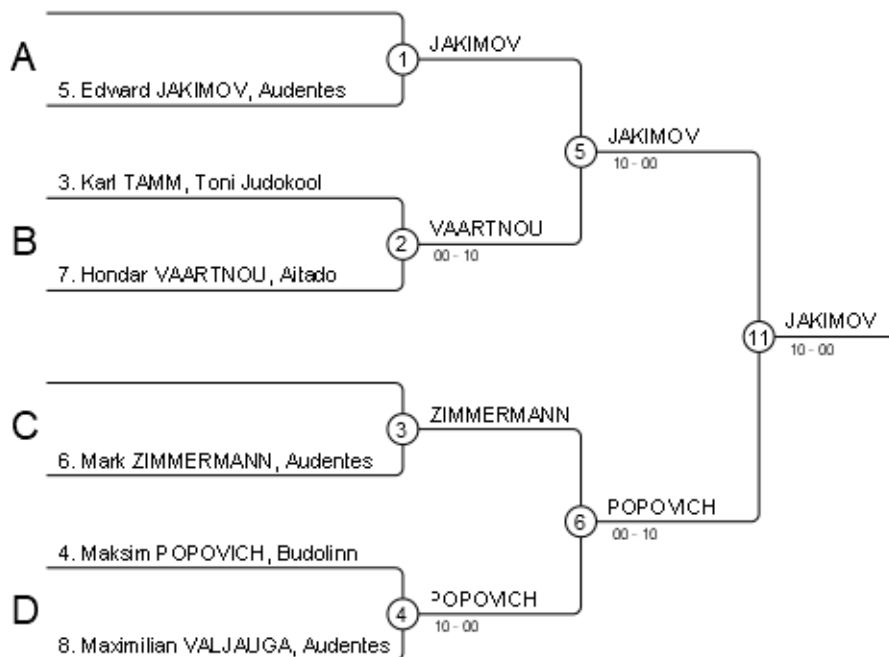

Results

Pos	Name
1	Edward JAKIMOV, Audentes
2	Maksim POPOVICH, Budolinn
3	Mark ZIMMERMANN, Audentes
3	Hondar VÄÄRTNÖU, Aitado
5	Karl TAMM, Toni Judokool
5	Maximilian VALJAJGA, Audentes
7	
7	

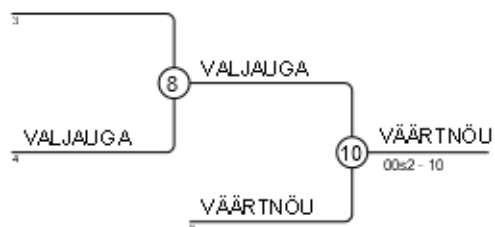
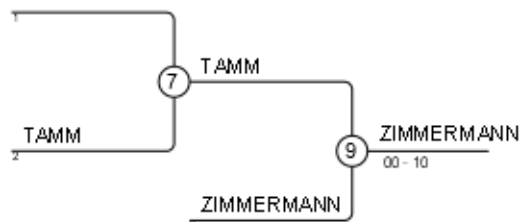

Judo III Superturniir 11.02.2019 Sole Spordihoone C -46kg

Competitors: 10

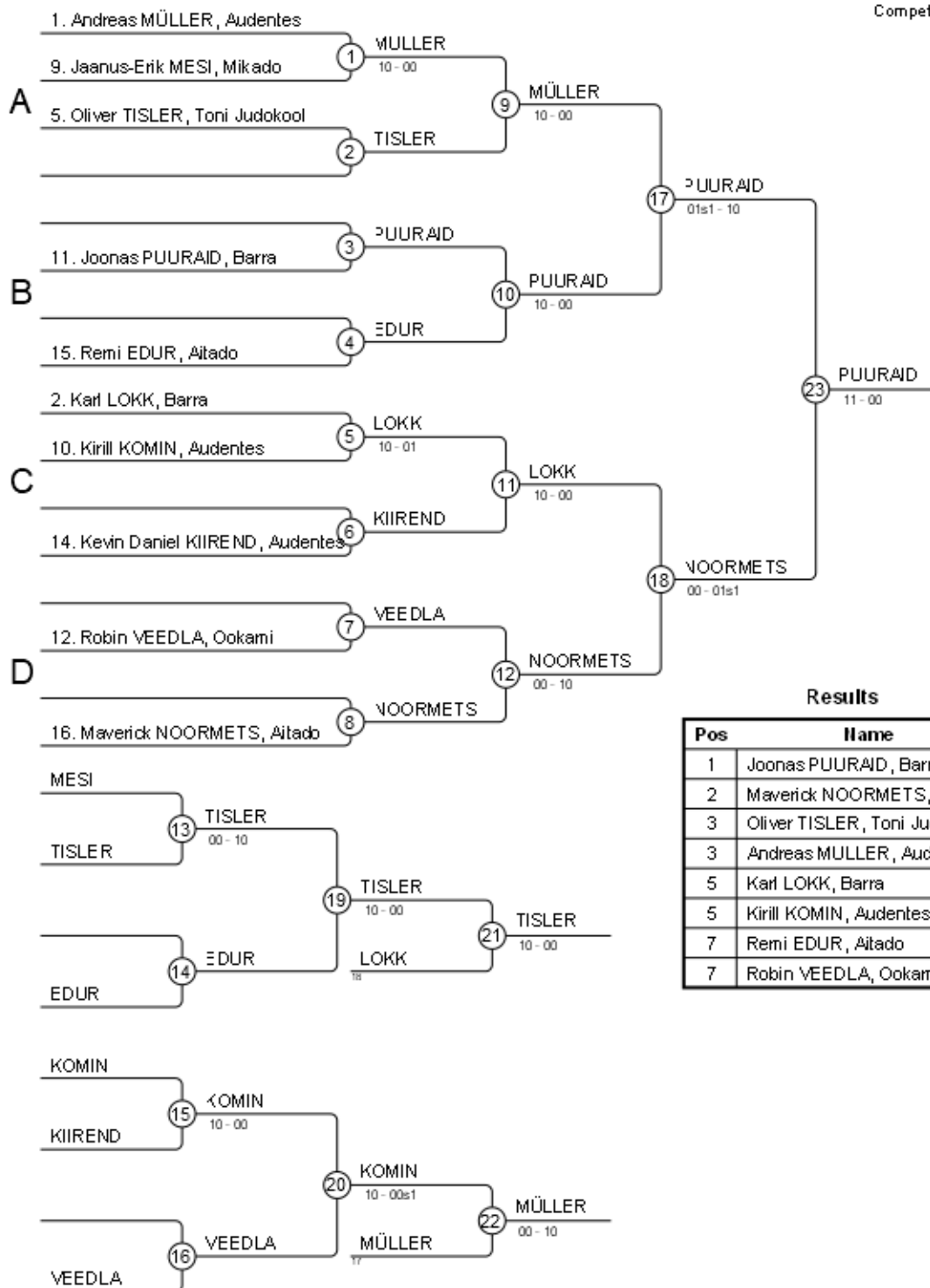

Results

Pos	Name
1	Joonas PUURAIID, Barra
2	Maverick NOORMETS, Aitado
3	Oliver TISLER, Toni Judokool
3	Andreas MULLER, Audentes
5	Karl LOKK, Barra
5	Kirill KOMIN, Audentes
7	Remi EDUR, Aitado
7	Robin VEEDLA, Ookami

Judo III Superturniir 11.02.2019 Sole Spordihoone C -50kg

Competitors

Competitors: 4

#	Name	Grade	Club	1	2	3	4	Wins	Pts	Pos
1	Kristjan KASESALU	?	Mikado		10	10	10	3	30	1
2	Hendrik PUURAIK	?	Barra			10	10	2	20	2
3	Armin-Ott TALPAS	?	Audentes				10	1	10	3
4	Marat VALUISKI	?	Kibuvits					0	0	4

Matches

Match	White		Blue		Result	Time
1	Kristjan KASESALU	1	2	Hendrik PUURAIK	10-00	2:05
2	Armin-Ott TALPAS	3	4	Marat VALUISKI	11-01	4:00
3	Kristjan KASESALU	1	3	Armin-Ott TALPAS	10-00	1:42
4	Hendrik PUURAIK	2	4	Marat VALUISKI	10-00	0:30
5	Kristjan KASESALU	1	4	Marat VALUISKI	10-00	1:44
6	Hendrik PUURAIK	2	3	Armin-Ott TALPAS	10-00	2:19

Results

Pos	Name
1	Kristjan KASESALU, Mikado
2	Hendrik PUURAIK, Barra
3	Armin-Ott TALPAS, Audentes
4	Marat VALUISKI, Kibuvits

Judo III Superturniir 11.02.2019 Sole Spordihoone C -55kg

Competitors: 6

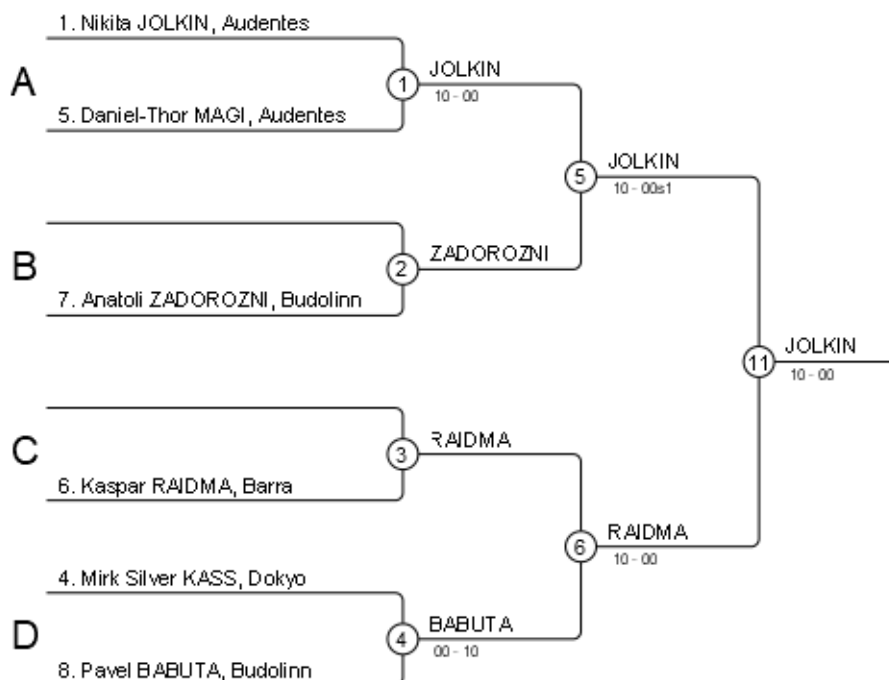

Results

Pos	Name
1	Nikita JOLKIN, Audentes
2	Kaspar RAIDMA, Barra
3	Pavel BABUTA, Budolinn
3	Anatoli ZADOROZNI, Budolinn
5	Daniel-Thor MÄGI, Audentes
5	Mirk Silver KASS, Dokyo
7	
7	

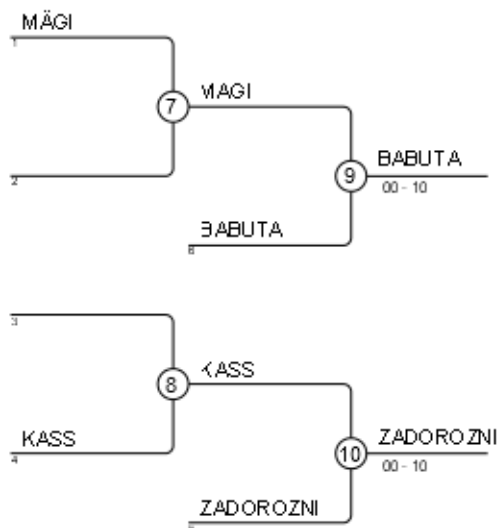

Judo III Superturniir 11.02.2019 Sole Spordihoone C -62kg

Competitors: 6

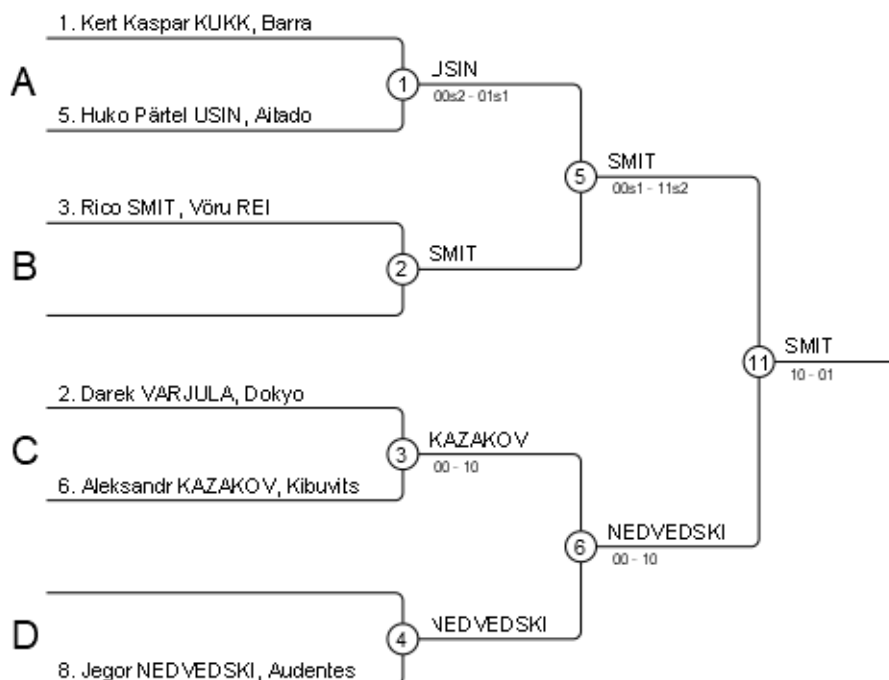

Results

Pos	Name
1	Rico SMIT, Võru REI
2	Jegor NEDVEDSKI, Audentes
3	Kert Kaspar KUKK, Barra
3	Huko Pärtel USIN, Aitado
5	Aleksandr KAZAKOV, Kibuvits
5	Darek VARJULA, Dokyo
7	
7	

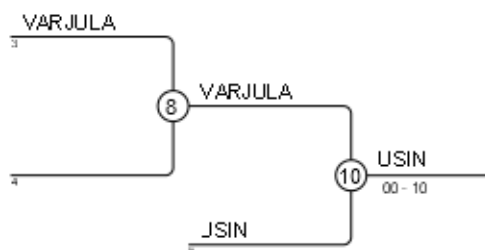
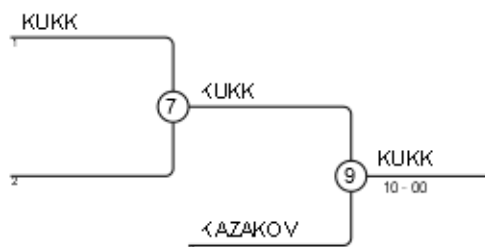

Judo III Superturniir 11.02.2019 Sole Spordihoone C -70kg

Competitors

Competitors: 5

#	Name	Grade	Club	1	2	3	4	5	Wins	Pts	Pos
1	Jevgeni LADÕGIN	?	Audentes		10	10	10	10	4	40	1
2	Jakob ANSLAN	?	Audentes			10	10		2	20	3
3	Adrian RANDLO	?	Võru REI						0	0	5
4	Taavi VAHTER	?	Barra			10			1	10	4
5	Tõnis DOMBERG	?	Barra		10	10	10		3	30	2

Matches

Match	White	Grade	Blue	Grade	Result	Time
1	Taavi VAHTER	4	Tõnis DOMBERG	5	00-10	0:13
2	Jevgeni LADÕGIN	1	Jakob ANSLAN	2	10-00	1:41
3	Adrian RANDLO	3	Taavi VAHTER	4	00-10	0:20
4	Jevgeni LADÕGIN	1	Tõnis DOMBERG	5	10-00	0:59
5	Jakob ANSLAN	2	Adrian RANDLO	3	10-00s2	1:42
6	Jevgeni LADÕGIN	1	Taavi VAHTER	4	10s1-00s2	1:21
7	Adrian RANDLO	3	Tõnis DOMBERG	5	00-11	0:34
8	Jakob ANSLAN	2	Taavi VAHTER	4	10-01	1:41
9	Jevgeni LADÕGIN	1	Adrian RANDLO	3	10-00s1	0:43
10	Jakob ANSLAN	2	Tõnis DOMBERG	5	00-10	1:00

Results

Pos	Name
1	Jevgeni LADÕGIN, Audentes
2	Tõnis DOMBERG, Barra
3	Jakob ANSLAN, Audentes
4	Taavi VAHTER, Barra
5	Adrian RANDLO, Võru REI

Judo III Superturniir 11.02.2019 Sole Spordihoone C +70kg

Competitors

Competitors: 3

#	Name	Grade	Club	1	2	3	Wins	Pts	Pos
1	Rasmus RITSON	?	Altia		10	10	2	20	1
2	Markus KAJAK	?	Altia				0	0	3
3	Kirill PELIH	?	Kibuvits		10		1	10	2

Matches

Match	White		Blue	Result	Time
1	Rasmus RITSON	1 2	Markus KAJAK	10-01	0:56
2	Rasmus RITSON	1 3	Kirill PELIH	10-00s3	1:50
3	Markus KAJAK	2 3	Kirill PELIH	00-10	0:08

Results

Pos	Name
1	Rasmus RITSON, Altia
2	Kirill PELIH, Kibuvits
3	Markus KAJAK, Altia

Judo III Superturniir 11.02.2019 Sole Spordihoone CG -33kg

Competitors

Competitors: 2

#	Name	Grade	Club	1	2	1	2	1	2	Wins	Pts	Pos
1	Annabel-Saskia JOAKIT	?	Toni Juddkool							0	0	2
2	Mirjam TIIDUMAA	?	Alia	7		10				2	17	1

Matches

Match	White	Blue	Result	Time
1	Annabel-Saskia JOAKIT	Mirjam TIIDUMAA	00-01s1	2:16
2	Annabel-Saskia JOAKIT	Mirjam TIIDUMAA	00-10	2:18
3	Annabel-Saskia JOAKIT	Mirjam TIIDUMAA		

Results

Pos	Name
1	Mirjam TIIDUMAA, Alia
2	Annabel-Saskia JOAKIT, Toni Juddkool

Judo III Superturniir 11.02.2019 Sole Spordihoone CG +40kg

Competitors

Competitors: 4

#	Name	Grade	Club	1	2	3	4	Wins	Pts	Pos
1	Kaisa ROSENBERG	?	Võru REI		10			1	10	3
2	Felis TALVIK	?	Dokyo					0	0	4
3	Emma Melis AKTAS	?	Alia	10	10		10	3	30	1
4	Henrietta LIPPUS	?	Barra	10	7			2	17	2

Matches

Match	White	White	Blue	Blue	Result	Time
1	Kaisa ROSENBERG	1	Felis TALVIK	2	10s1-00s1	1:06
2	Emma Melis AKTAS	3	Henrietta LIPPUS	4	10-00	0:54
3	Kaisa ROSENBERG	1	Emma Melis AKTAS	3	00-10	0:43
4	Felis TALVIK	2	Henrietta LIPPUS	4	00s2-01s1	2:00
5	Kaisa ROSENBERG	1	Henrietta LIPPUS	4	00-10	0:18
6	Felis TALVIK	2	Emma Melis AKTAS	3	00-10	0:08

Results

Pos	Name
1	Emma Melis AKTAS, Alia
2	Henrietta LIPPUS, Barra
3	Kaisa ROSENBERG, Võru REI
4	Felis TALVIK, Dokyo